

Work Breakdown Structure

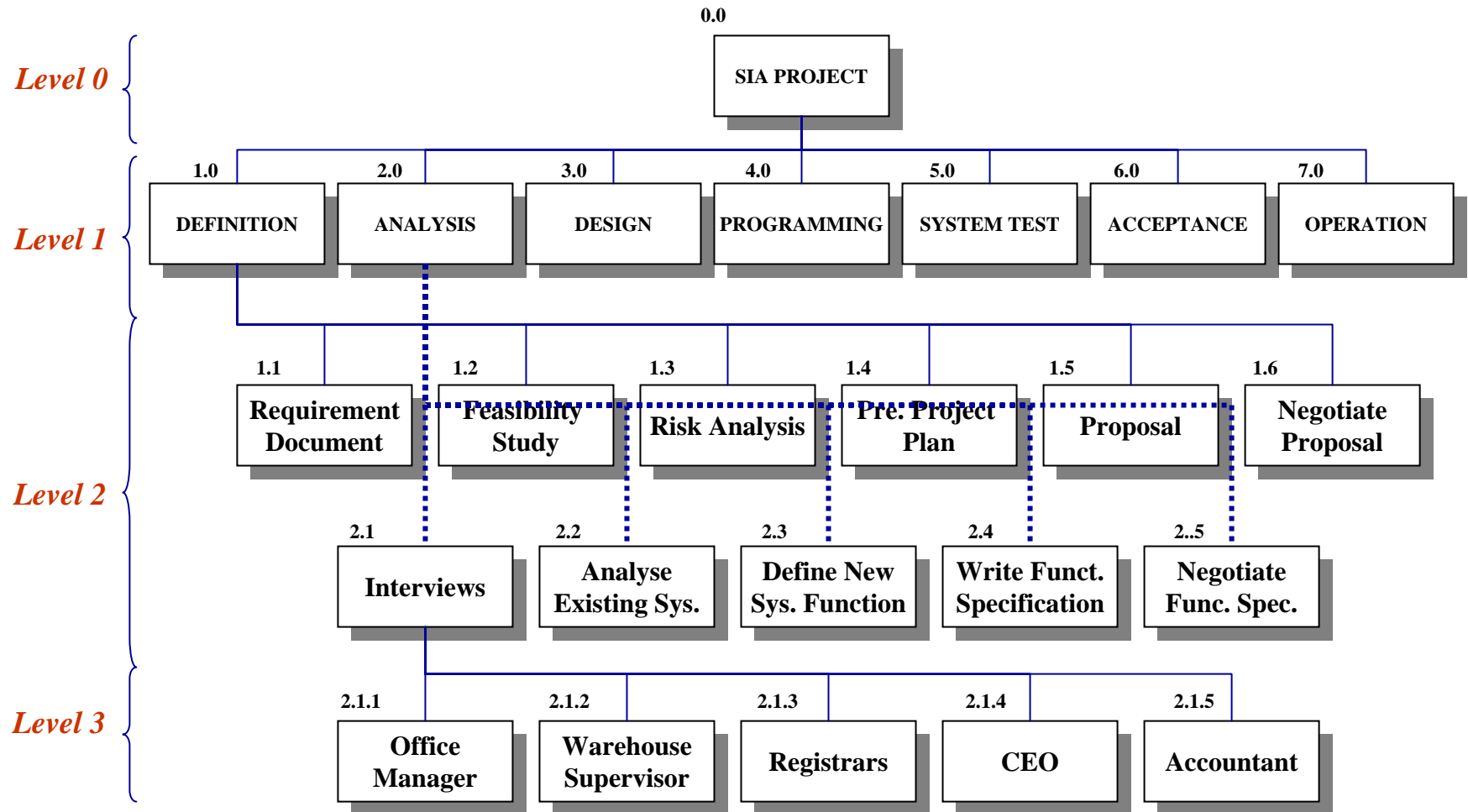

Jenis WBS Proyek Intranet

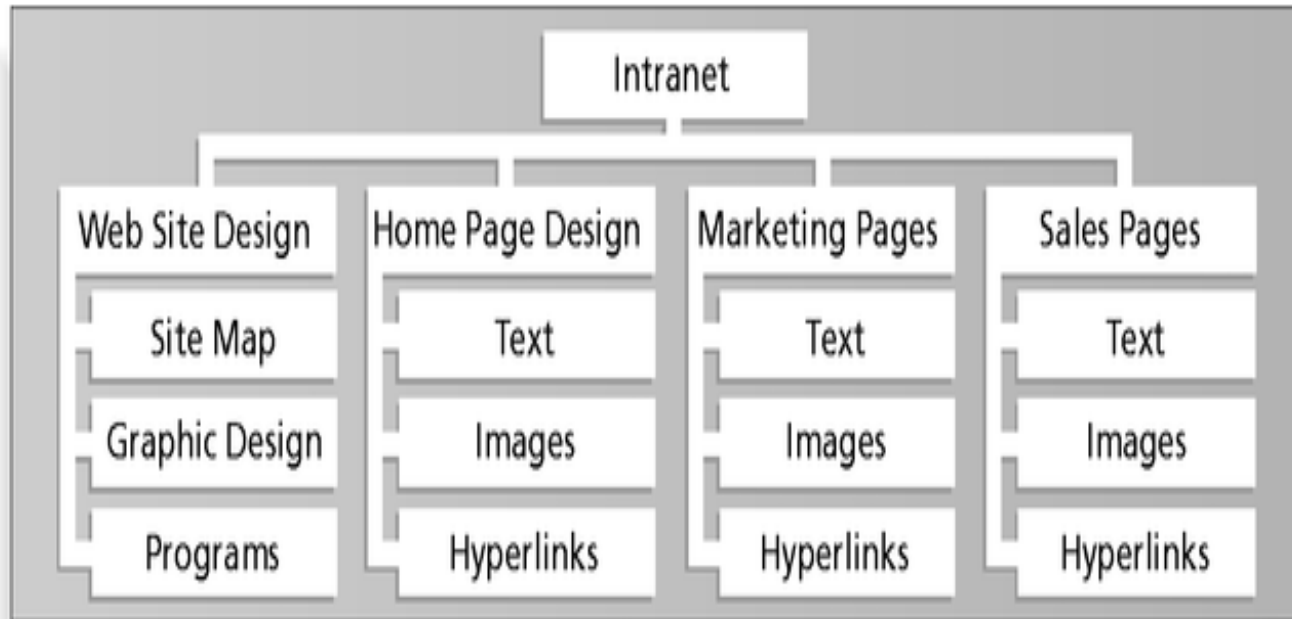

Figure 5-6. Sample Intranet WBS Organized by Product

Jenis WBS Proyek Intranet

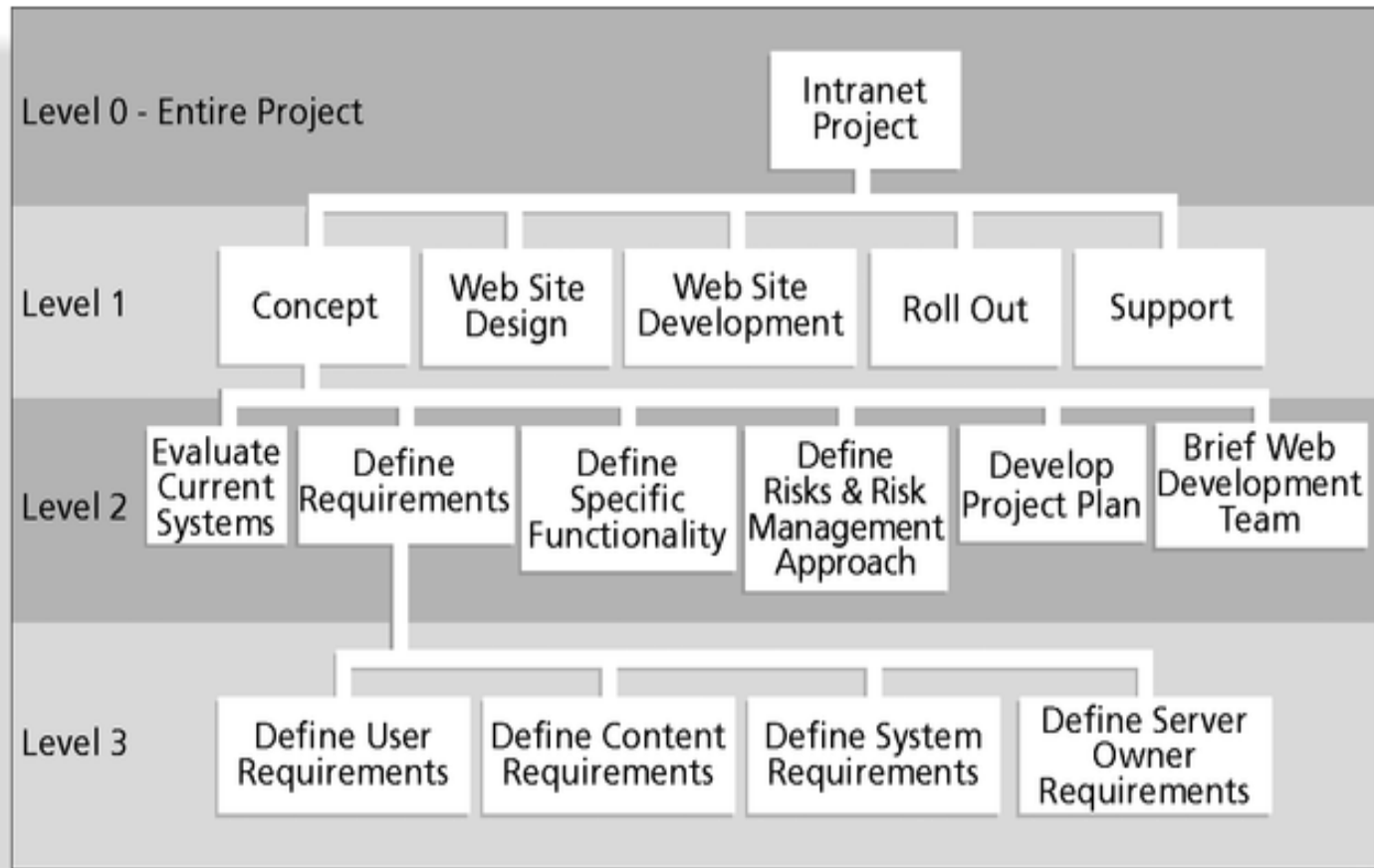

Figure 5-7. Sample Intranet WBS Organized by Phase

WBS Intranet pada Tabular Form

1.0 Concept

1.1 Evaluate current systems

1.2 Define Requirements

1.2.1 Define user requirements

1.2.2 Define content requirements

1.2.3 Define system requirements

1.2.4 Define server owner requirements

1.3 Define specific functionality

1.4 Define risks and risk management approach

1.5 Develop project plan

1.6 Brief Web development team

2.0 Web Site Design

3.0 Web Site Development

4.0 Roll Out

5.0 Support

WBS Intranet pada Gantt Chart

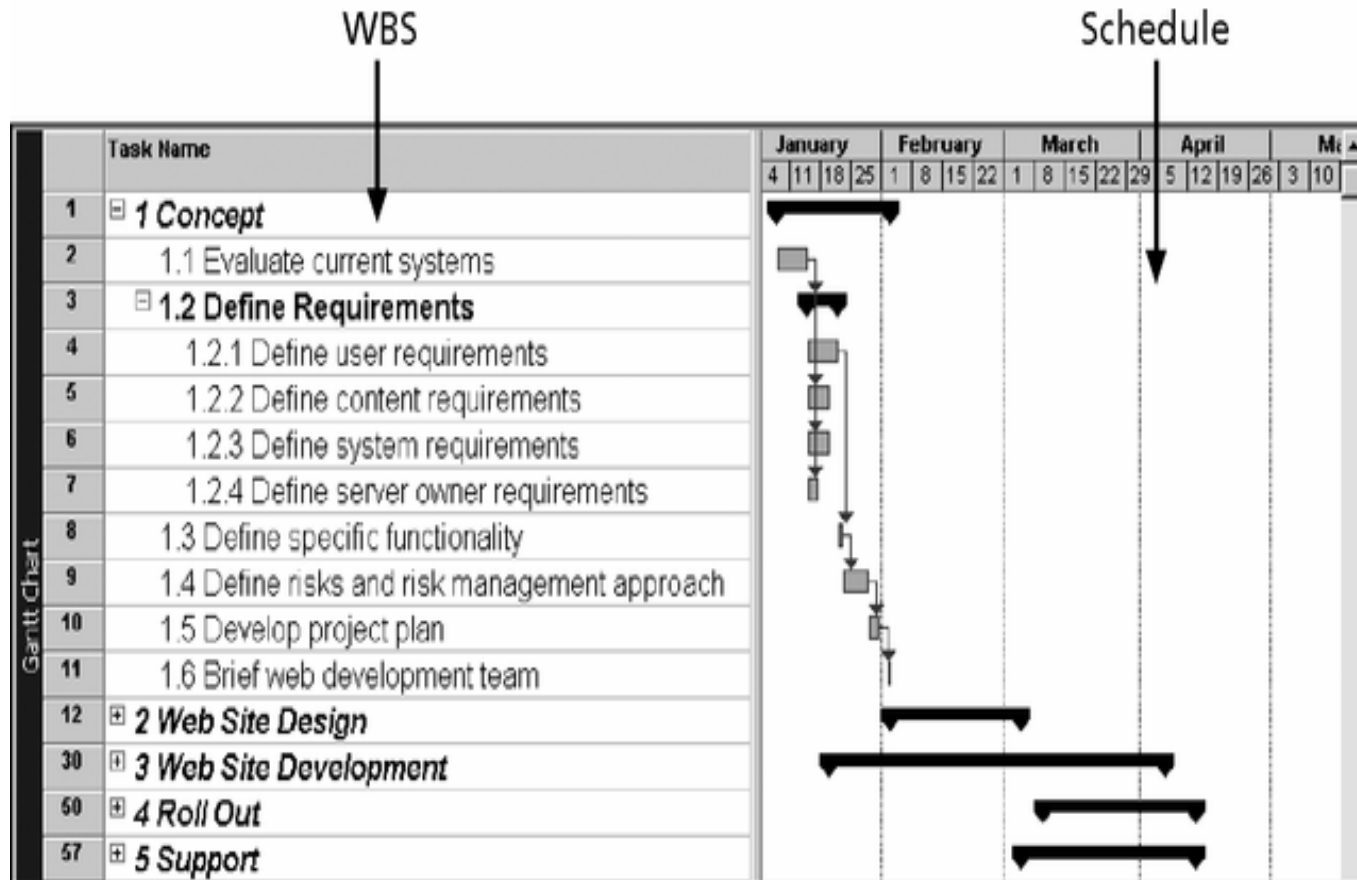
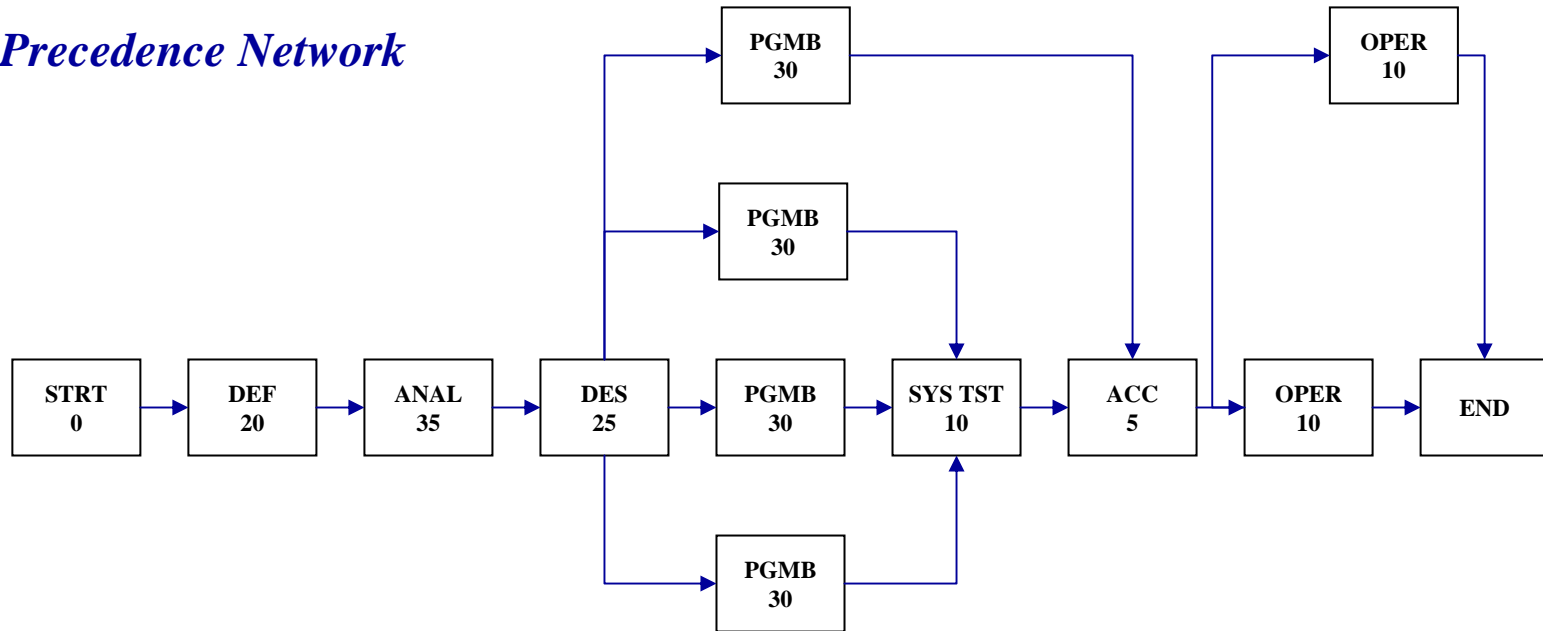

Figure 5-8. Intranet Gantt Chart in Microsoft Project

Precedence Network

Precedence Network



*Another Format
Activity on Arrow*

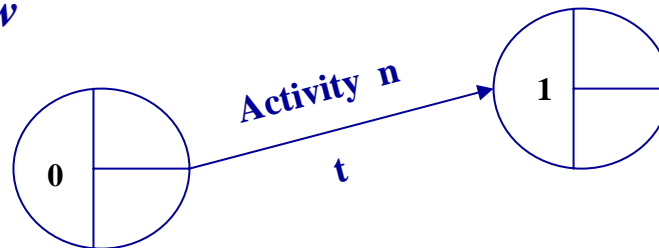

Critical Path Method

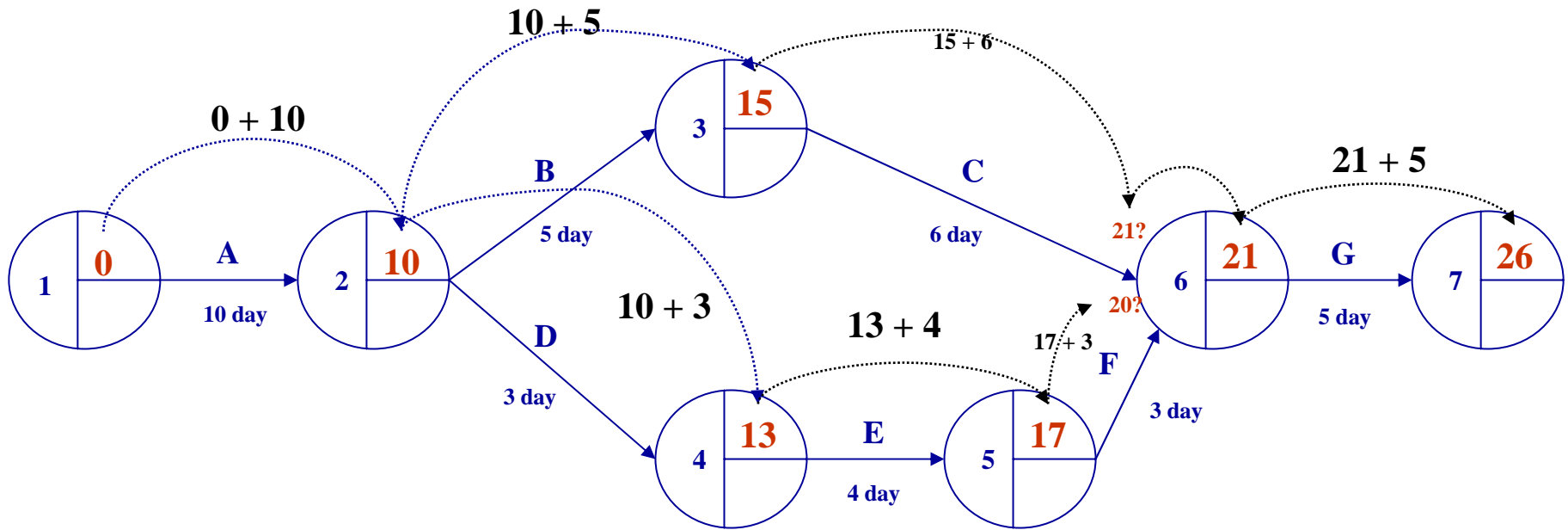

Critical Path

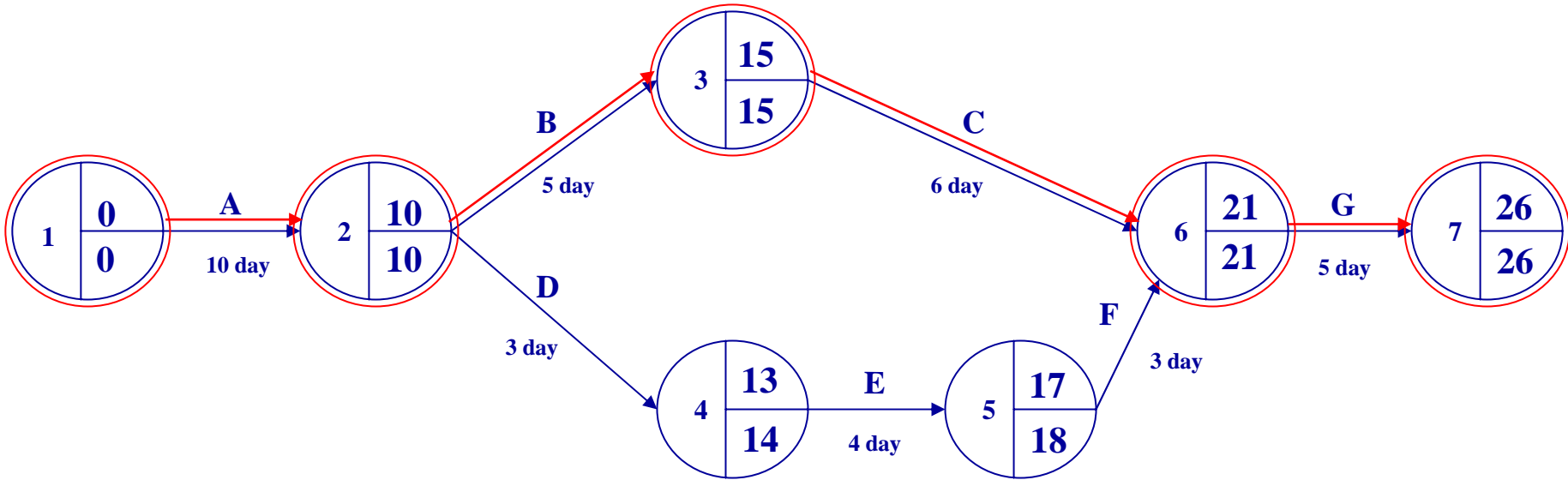

Project Duration : 26 day

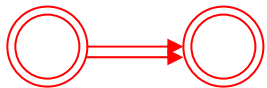

: Critical path